



January 15-18, 2024
Exhibits Open January 16-18
Conference January 15

Exhibit Specifications

These expanded Exhibit Specifications have been adopted to give each exhibitor more effective use of space without infringing on the rights of neighboring booths. Rules and Regulations including updated exhibit specifications are found in the online Exhibitor Service Manual, which is available approximately 90 days from the event.

PPAI reserves the right to ensure that the equipment and product being displayed is not placed in the booth in a manner which obstructs other exhibitors' displays. Any equipment or product scheduled for exhibition, which could possibly cause a conflict or infraction, should be cleared and approved by PPAI by November 10, 2023.

The price of your exhibit space includes (8') back and (3') side drape, 9x10 carpet in the official show color and a company identification sign. Exhibitors will not be permitted to purchase back-to-back booths and remove the existing back drape. Exhibitors may purchase multiple 10x10 booths in a row and remove the existing side rails between the booths.

If you have any questions about your exhibit configuration, these Exhibit Specifications or any matter pertaining to exhibiting at PPAI events, call the PPAI Expositions Department at 888.I.AM.PPAI (888.426.7724).

SALES CONTACT INFORMATION

Connie Brazil, Account Manager | 972.258.3064 | Southeast

Sandy Mendoza, Account Manager | 972.258.3019 | Central

Taylor Coward, Account Manager | 972.258.3033 | West

Heather Mangold, Account Manager | 972.258.3067 | Northeast



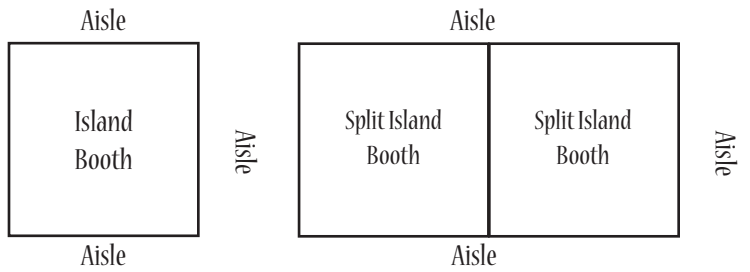
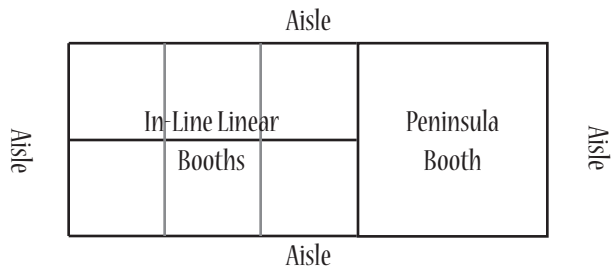

LINEAR BOOTH

Linear booths have one side exposed to an aisle and are generally arranged in a series along a straight line. They are also called “in-line” booths.

Dimensions:

For purposes of consistency and ease of layout and/or reconfiguration, floor plan design in increments of ten feet (10') has become the de facto standard in the United States. Therefore, unless constricted by space or other limitations, Linear booths are ten feet (10') deep, i.e. 10'x10'. A maximum back wall height limitation of eight feet (8') is allowed, unless an extended height fee of twelve percent (12%) is paid to be allowed to extend up to ten feet (10') high.

USE OF SPACE

Regardless of the number of Linear booths utilized, (e.g. 10'x20', 10'x30', 10'x40', etc.) display materials should be arranged in such a manner so as not to obstruct sight lines of neighboring exhibitors. The maximum height of eight feet (8') is allowed only in the rear half of the booth space, with a four foot (4') height restriction imposed on all materials in the remaining space forward to the aisle. (Note: When three (3) or more Linear booths are used in combination as a single exhibit space, the four foot (4') height limitation is applied only to that portion of exhibit space which is within ten feet (10') of an adjoining booth.)

PERIMETER BOOTH

A Perimeter booth is simply a Linear booth that backs up to a wall of the exhibit facility rather than to another exhibit.

Dimensions And Use Of Space:

All guidelines for Linear booths apply to Perimeter booths except that the extended height fee of twelve percent (12%) is paid to be allowed to extend up to sixteen feet (16') high.

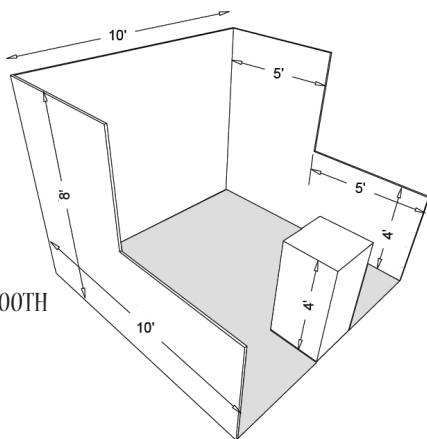
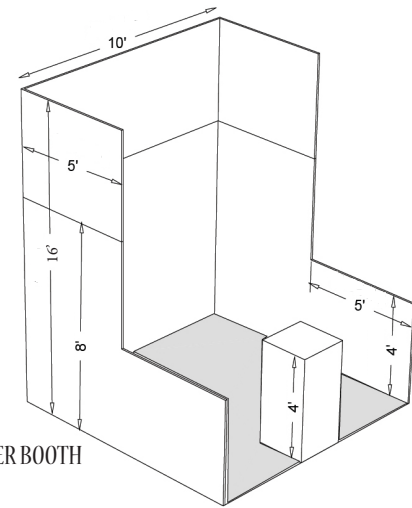

ISLAND BOOTH

An Island booth is any 20'x20' booth or larger exposed to aisles on all four sides.

Use Of Space:

The entire cubic content of the space may be used up to the maximum allowable height, which is sixteen feet (16'), including ground supported signage, without paying an additional twelve percent (12%) upcharge. Twenty-two feet (22') is the maximum height allowed when paying the twelve percent (12%) extended height upcharge. All hanging signage and graphics requires an additional upcharge. See the Hanging Signs And Graphics section on page 3 for details. For any ground supported structure requiring rigging support from the ceiling an additional twelve percent (12%) upcharge will be enforced, as if it were hanging signage.

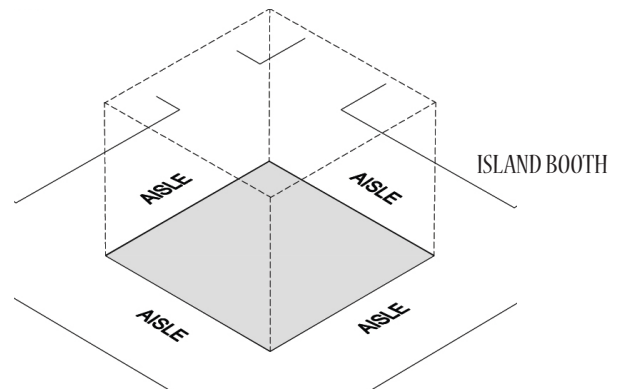

CORNER BOOTH

A Corner booth is defined as a booth exposed to an aisle on two sides, or a booth without an adjacent exhibitor within ten (10) feet.

PREFERRED BOOTH

A Preferred booth is defined as a Linear booth without an adjacent exhibitor within ten (10) feet as noted on the floor plan.

PENINSULA BOOTH

A Peninsula booth is exposed to aisles on three (3) sides and composed of a minimum of four booths: (a) one that backs up to Linear booths, and (b) one that backs up to another Peninsula booth and is referred to as a "Split Island Booth."

Dimensions:

A Peninsula Booth is 20'x20' or larger. When a Peninsula Booth backs up to two Linear Booths, the back wall is restricted to four feet (4') height within five feet (5') of each aisle, permitting adequate line of sight for the adjoining Linear Booths. Twelve feet (12') is the maximum height allowance, including signage for the center portion of the back wall, without paying an additional twelve percent (12%) upcharge. Sixteen feet (16') is the maximum height allowed when paying the twelve percent (12%) upcharge, including signage for the center portion of the back wall.

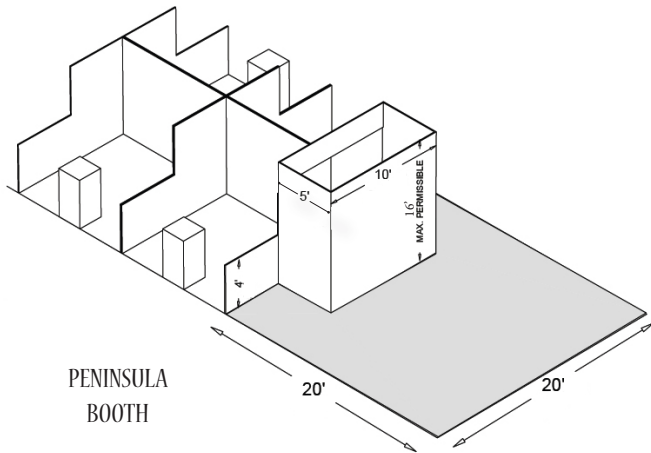

MULTI-STORY/CANOPIES/CEILINGS

Canopies, including ceilings, umbrellas and canopy frames, can be either decorative or functional (such as to shade computer monitors from ambient light or for hanging products). Canopies for Linear or Perimeter Booths should comply with line of sight requirements (see "Use of Space for Linear or Perimeter Booths").

The base of the Canopy should not be lower than seven feet (7') from the floor within five feet (5') of any aisle. Canopy supports should be no wider than three inches (3"). This applies to any booth configuration that has a sightline restriction, such as a Linear Booth.

Multi-Story Exhibits follow the same guidelines as Island Booths. See Island Use of Space on page 2.

Any exhibitor utilizing Multi-Level/Canopies/Ceilings exhibits or covered exhibits must notify PPAI Show Management in writing no later than 60 days from opening date of event, for approval and further instruction.

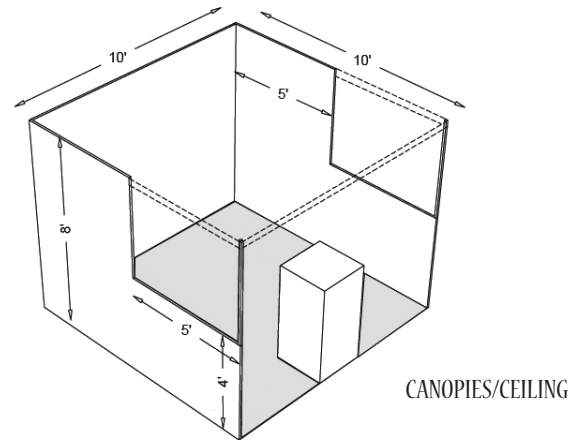

SPLIT ISLAND BOOTH

A Split Island Booth is a Peninsula Booth, which shares a common back wall with another Peninsula Booth. The entire cubic content of this booth may be used, up to the maximum allowable height, without any back wall line of sight restrictions. Twelve feet (12') is the maximum height allowance, including signage for the center portion of the back wall, without paying an additional twelve percent (12%) upcharge. Sixteen feet (16') is the maximum height allowed when paying the twelve percent (12%) upcharge, including signage for the center portion of the back wall. The entire cubic content of the space may be used up to the maximum allowable height. Exhibitor is responsible for covering cost of structure and signage used in the center portion of the back wall.

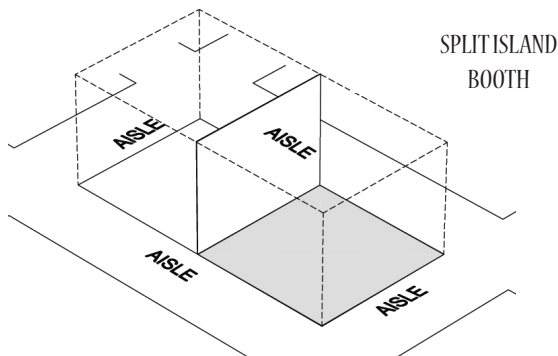

TOWERS

A Tower is a freestanding exhibit component separate from the main exhibit fixture that is used for identification display purposes only. The height is the same as that which applies to the appropriate exhibit configuration being used.

EXTENDED HEIGHT

Extended height may be purchased for your space for an additional twelve percent (12%) of your total exhibit space cost, based on your booth configuration. Exhibitor is responsible for covering cost of structure and signage used in the extended height area. Please note the following Extended Height allowances:

- Linear - 10' at 12% upcharge.
- Island - 22' at 12% upcharge.
- Peninsula - 16' at 12% upcharge.
- Perimeter - 16' at 12% upcharge.

HANGING SIGNS AND GRAPHICS

Hanging Sign permission may be purchased for your space for an additional twelve percent (12%) of your total exhibit space cost. Hanging Signs are only allowed on Aisle Spans (six [6] booths or greater), Island and Peninsula booths. Height is measured from the floor to the top of the hanging sign/graphic. Please note the following height allowances:

- Aisle Span - 16' at 12% upcharge.
MUST ALSO PURCHASE AISLE CARPET SPAN. Exhibitor is responsible for covering cost of carpet and signage used in the Aisle Span.
- Island - 22' at 12% upcharge.
- Peninsula - 16' at 12% upcharge.

Exhibitor is responsible for covering cost of signage and graphics used in the area.

AISLE CARPET SPAN

Linear exhibits with at least six hundred (600) square feet of exhibit space and at least three (3) booths on each side of the aisle facing each other may choose to have carpet spanned over the aisle. This option will incur a Special Booth Configuration fee of twelve percent (12%) of your total exhibit cost. The aisle must be free of any exhibit items and be maintained as an aisle. Aisle carpet spans cannot contain more than a single pad under the carpet. Exhibitor is responsible for covering cost of carpet and carpet pad used in the aisle carpet span area.

ELEVATED AISLE SPAN

Linear exhibits with at least six hundred (600) square feet of exhibit space and at least three (3) booths on each side of the aisle facing each other may choose to have an aisle span over the aisle. This option will incur a Special Booth Configuration fee of twelve percent (12%) of your total exhibit cost. An exhibitor may "bridge or span" the aisle if they are in accordance with the following rules:

- The "bridge or span" must be structural a component of the booth such as a roof or a sign that conforms to the architectural integrity of the booth and the bridge.
- The maximum height of the "bridge or span" can only be ten (10') feet (to top of span from the exhibit floor).
- **MUST ALSO PURCHASE AISLE CARPET SPAN.**

Exhibitor is responsible for covering cost of structure and signage used in the Elevated Aisle Span.

ADDITIONAL NOTES

Should your booth exceed eight (8') feet in height, and you back up to another exhibitor's booth, you must "finish" the portion of your booth that exceeds eight (8') feet and backs up to your neighbor's booth. PPAI reserves the right to have the decorator make adjustments to unfinished portions of your booth that back up to neighboring booths at your expense. The additional fees paid to PPAI for special booth configurations are in addition to any charges by show decorator or the facility for equipment and labor to make these modifications.

All booths are 10'x10' unless otherwise noted. All aisles are ten (10') feet unless otherwise noted.

Exhibitors purchasing upcharged items are responsible for covering cost of materials such as carpets, pads, signage and structures in addition to the cost for the upcharge. Exhibitors are also responsible for covering the cost to install these items.

Exhibit Specifications are subject to change at the discretion of Show Management. All updates will be posted to the Exhibitor Service Manual online at <http://expo.ppai.org>.



Promotional Products Association International
3125 Skyway Circle North
Irving, TX 75038
888.426.7724
<http://expo.ppai.org>